

# Install Manual

## (QPI-AUDI-CMD-V3.2)

---

# Warning / Caution



## Warning

- When installing the main unit, do not remove or alter existing vehicle fasteners, including nuts, bolts, screw, clips, and fittings. Never detach, move or alter existing vehicle wiring, including electrical grounds and straps. Alteration of existing vehicle components may make vehicle unsafe to operate. Should be no any electronic devices or magnetic pole around installation place.
- Air bags are vital part of a safety system. Never install main unit in a way which will alter air bag wiring or interfere with air bag deployment. Air bags must function properly in the event of an accident.
- Before installing, check the location of pipe, tank, electrical cables and others.
- Read and follow the instruction manual.
- Wiring location must not interfere driving, get in or out from car.
- Use electrical tape to insulate the ends of all wires, even if they are not used. Proper insulation prevents arcs, shocks and fires.
- When installation is complete, test all vehicle electrical systems to ensure they operate correctly, including lights, horn, brake lights, and emergency flashers.
- According to our sales policy, any problems caused by user's mistake, careless can not be guaranteed.



## Caution

- All steps of installation should be done by well-trained specialist.
- During installation ignition key should be taken off and after all installation finish connect power cable with interface for the last step.
- Do not install the main unit in places where it ma be exposed to dew condensation (around the air conditioning hose, etc), or in locations where it may come in contact with water, high levels of moisture, dust or oily smoke
- Install wiring in a manner in which cables will not come in contact with metal parts. The wiring may be damaged by contact with metal parts, resulting in fire and shocks. Avoid all contact with hot surfaces when wiring the main unit. High temperatures may damage wiring, causing shorts, arcing and fires.
- Kindly check all parts are in the box, when receiving the product, if anything missing, inform to the supplier or manufacturer.

# Table of Contents

---

1. Specifications	
1.1 Main Specifications-----	4
1.2 Features -----	5
1.3 System Diagram -----	6
1.4 Components -----	7
1.5 Exterior -----	9
2. Installation	
2.1 Installation Diagram-----	10
2.2 Installation -----	11
3. Settings	
3.1 DIP Switch -----	12
3.2 Remote Control -----	13
3.3 Factory Menu	
3.3.1 Image, Park-----	14
3.3.2 UTIL1 -----	16
3.3.3 UTIL2 -----	18
3.4 Original Button Usage -----	22
3.5 OSD-----	23
4. Trouble Shooting -----	25

# 1. Specifications

---

## 1.1 Main Specifications

1. Car Compatibility  
AUDI Cars in combination with MMI 3G, 3G+
2. Components  
Interface\* 1EA
3. MULTIMEDIA INTERFACE input specification
  - 3 \* A/V input (video external input)
  - 1 \* CVBS(Rear Camera) input
  - 1 \* Analog RGB input (Navigation system output)
  - 1 \* LCD input (Car system input)
4. MULTIMEDIA INTERFACE output specification
  - 1 \* LCD output
5. Power specification
  - Input power : 8VDC ~ 18VDC
  - Consumed power : 5WATT
6. Switch input mode
  - External display skip function : through DIP switch, can control each video input
  - Through remote control, can change input mode
  - Through CAN or rear lamp cable, rear camera can be detected

# 1. Specifications

---

## 1.2 Features

- Easy installation through connection with command
- Able to control NAVI, DVD, DTV function by using I-Drive Controller
- Able to adjust DVD, NAVI display on screen
- Improved Screen Display (user-oriented interface)
- Mode change through original button
- Provide power cable to connect with rear camera
- Dynamic PAS(Parking assistance system)+PDC, moving parking line according movement of steering wheel

# 1. Specifications

## 1.3 System Diagram

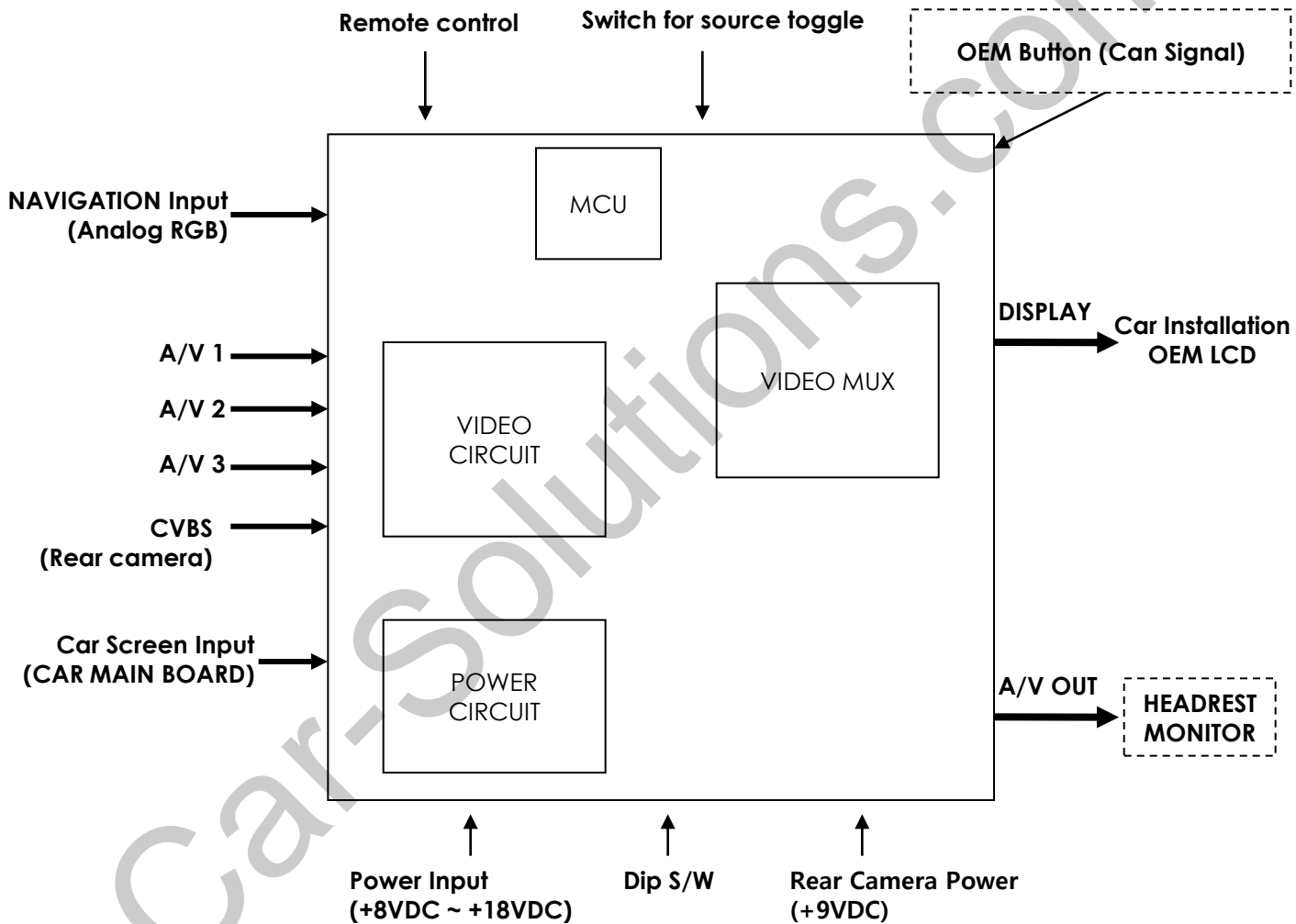

# 1. Specifications

## 1.4 Components

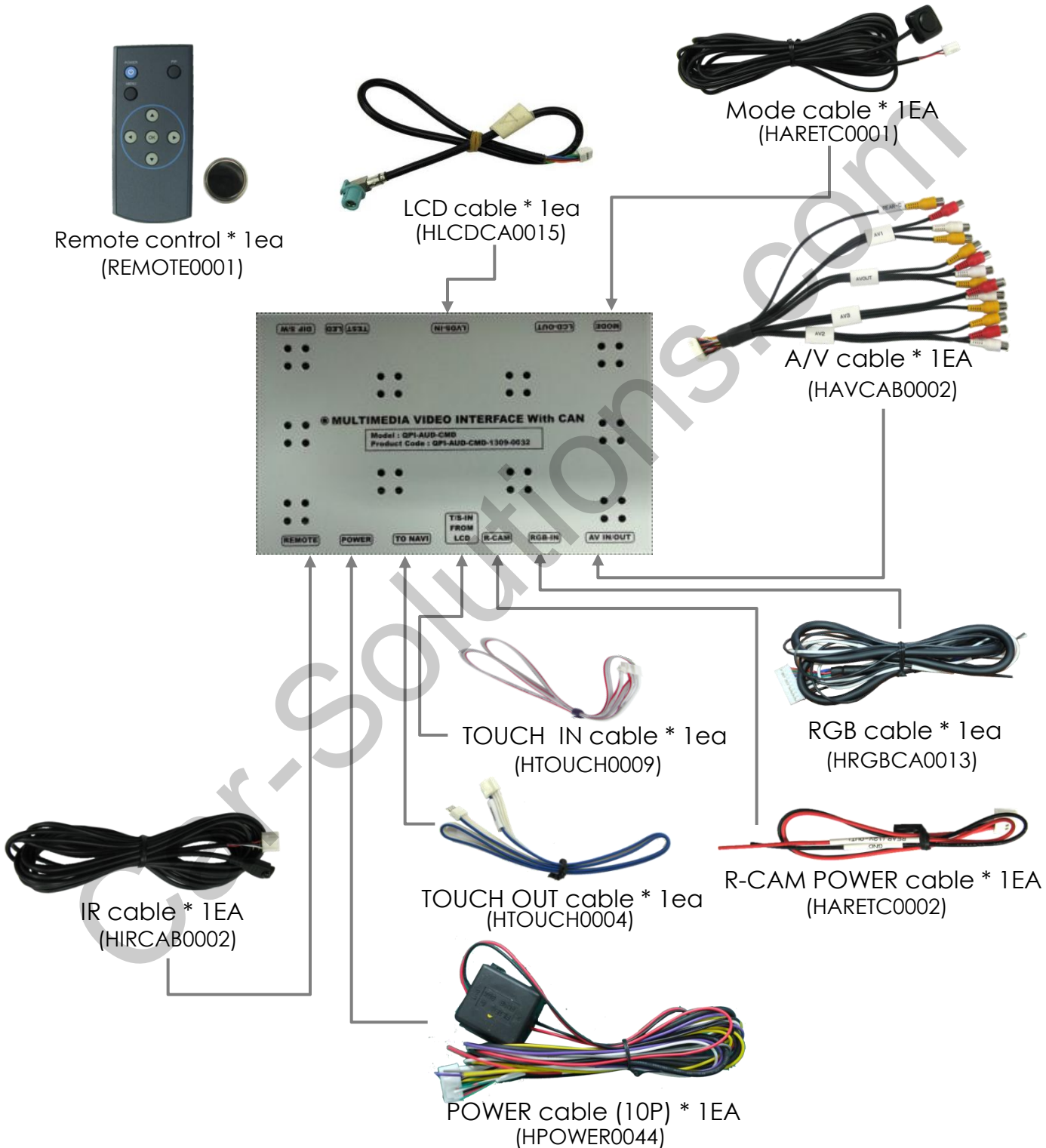

# 1. Specifications

---

## 1.4 Components



7" Touch Panel  
(TOULCD0013)



8" Touch Panel  
(TOUPAN0004)



# 2. Installation

## 2.1 Installation Diagram

### Connecting CAN wire

※ In case of 3G+ Vehicles(Q3, A6, A7)

Connect CAN-H-HS(Brown+Green-3Pin) of the interface to CAN High(Orange+Blue) of the car  
Connect CAN-L-HS(Green-4pin) of the interface to CAN Low(Orange+Brown) of the car

※ In case of 3G Vehicles(Q5, Q7, A4, S4)

Connect CAN-H-LS(Brown+Green-9Pin) of the interface to CAN High(Orange+Green) of the car  
Connect CAN-L-LS(Green-10Pin) of the interface to CAN High(Orange+Brown) of the car

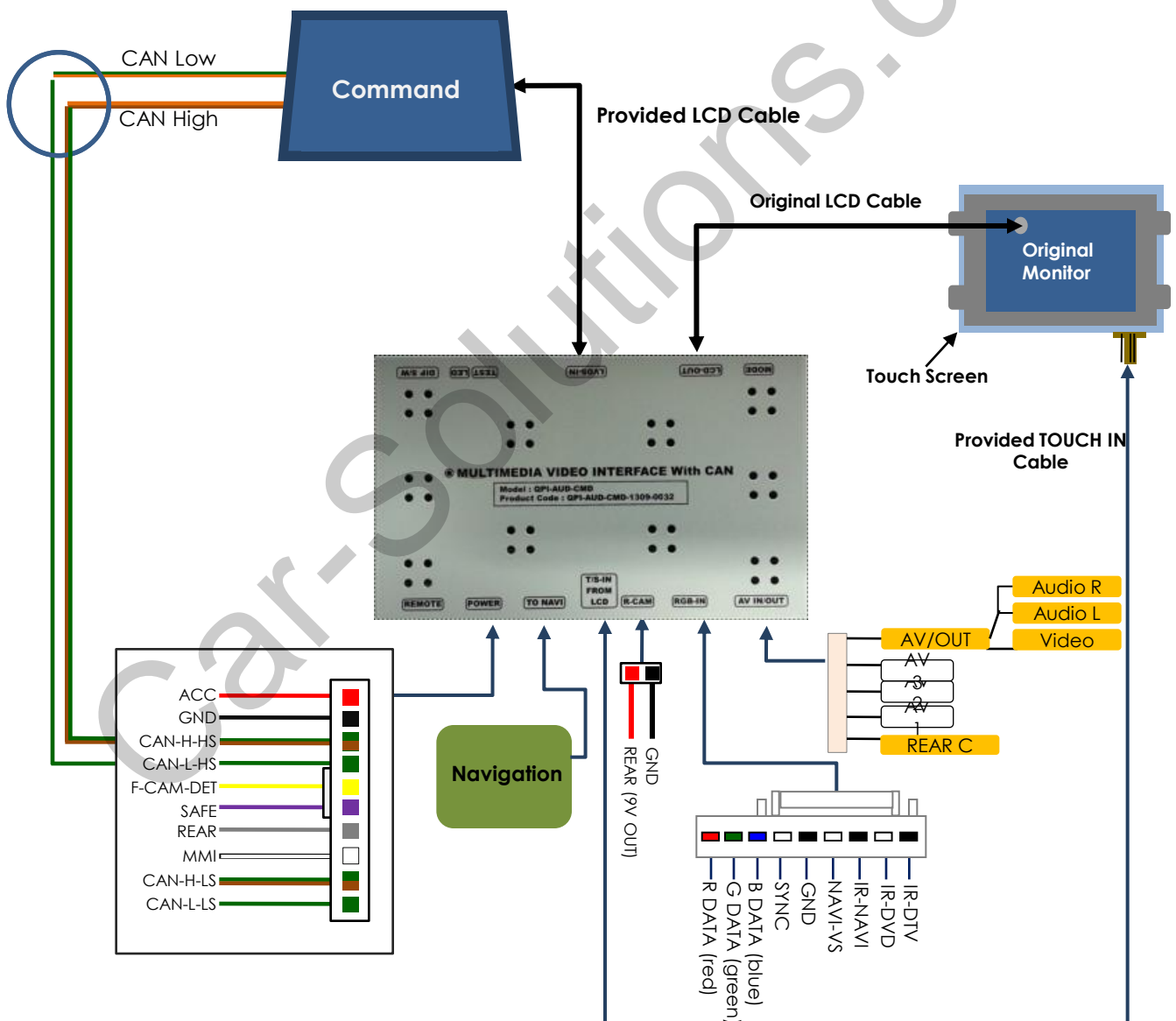

# 2. Installation

## 2.2 Installation

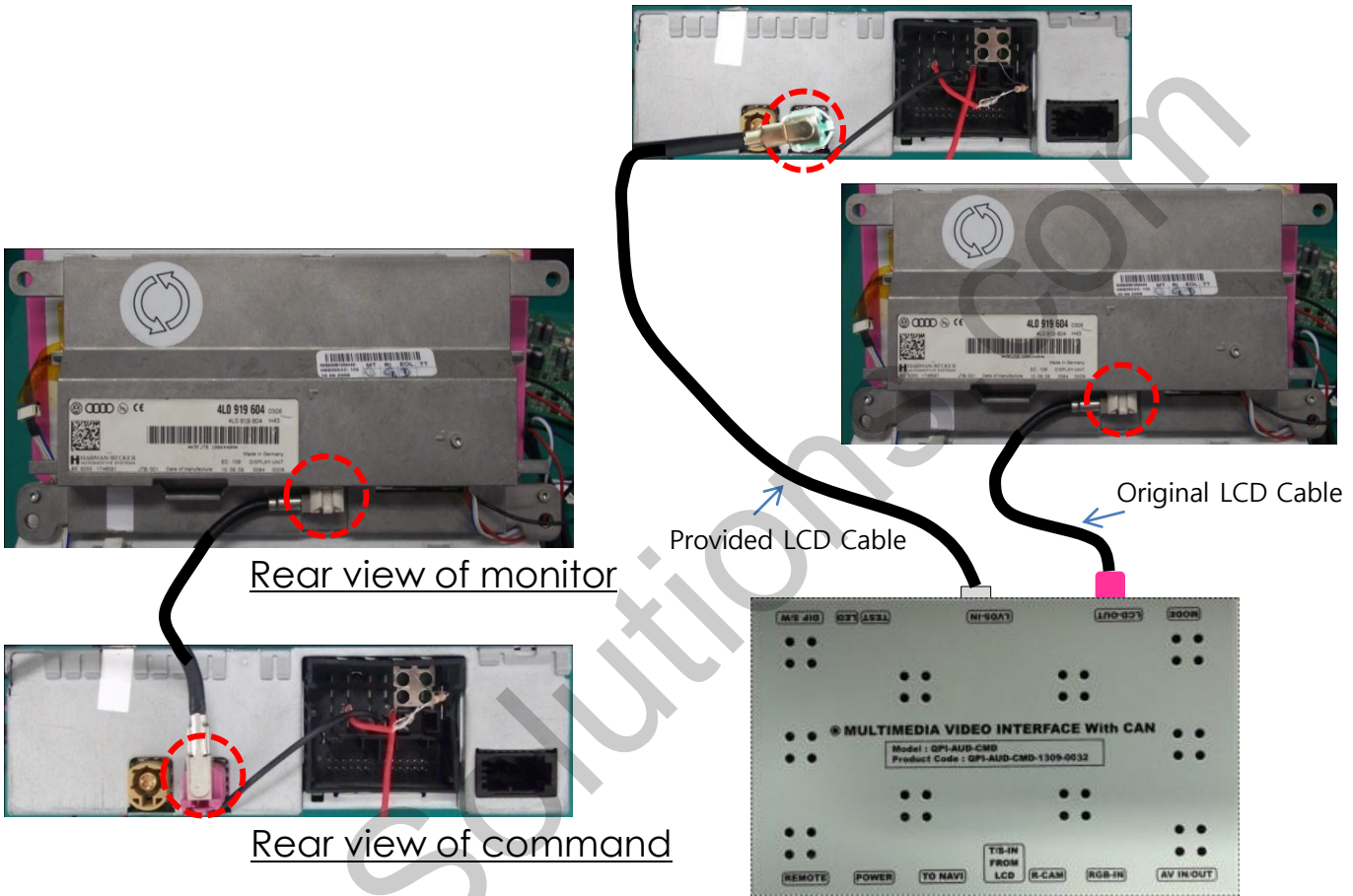

- ① Here are pictures of the rear view of the disassembled monitor and command.

You can see that original LCD cable of monitor is connected to the command in the picture above.

- ② Connect the original LCD cable to "LCD-OUT" of the Interface after disconnecting it from the command.

And connect the LCD cable enclosed in our package to "LVDS-IN" of the Interface. Then connect the opposite end of the cable to the spot that the original LCD cable is connected of command

# 2. Installation

## 2.2 Installation / MMI wire connection

### ※ CAN wire connection



① Find the same cable as picture #1 above behind the AC equipment of car.

※ A6, A7 (High)

#4 pin : CAN-HI(Orange/Blue) → Provided power cable #3 pin  
CAN-H-HS(Green/Brown)

#5 pin : CAN-LOW(Orange/Brown) → Provided power cable #4  
pin CAN-L-HS(Green)

※ Q5, Q7, A4, S4 (Low)

#4 pin : CAN-HI(Orange/Brown) → Provided power cable #3 pin  
CAN-H-LS(Green/Brown)

#5 pin : CAN-LOW(Orange/Brown) → Provided power cable #4  
pin CAN-L-LS(Green)

# 2. Installation

---

## 2.2 Installation / MMI wire connection

※ CAN wire connection (Q3)

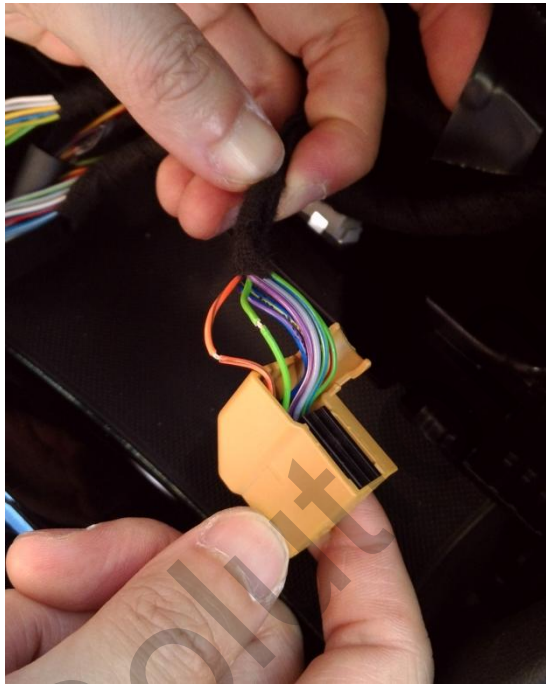

---

※ Q3 car model

① Behind the center air vent, find the cable connector as shown above.

#12 pin of OEM cable(Green) → Provided power cable #9 pin / CAN-H-LS(Green/Brown)

#13 pin of OEM cable(Orange)→ Provided power cable #10pin / CAN-L-LS(Green)

# 2. Installation

## 2.2 Installation / MMI wire connection

### ※ MMI wire connection

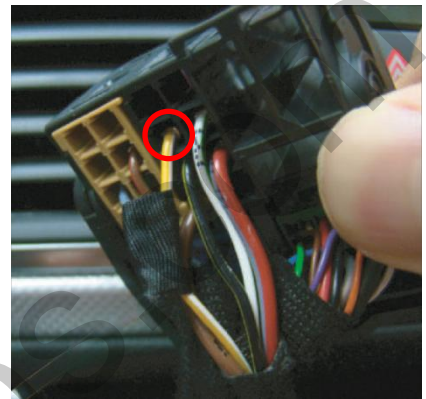
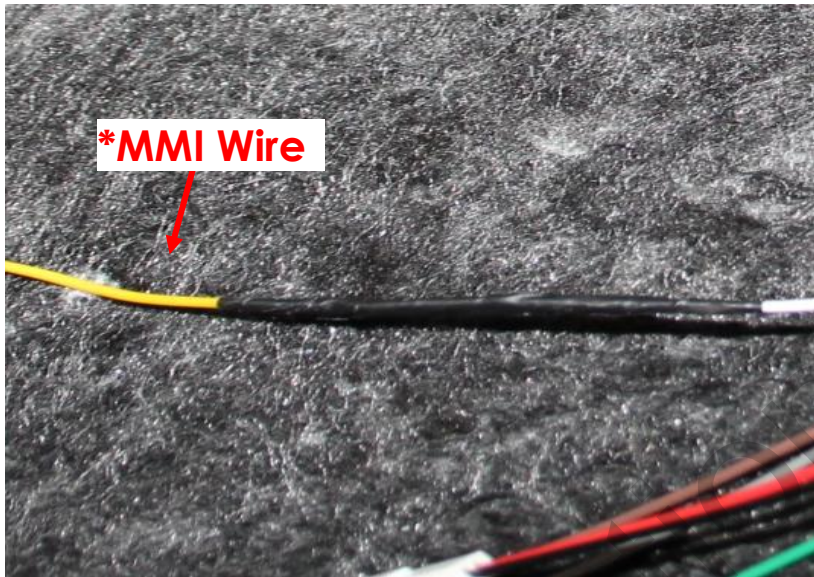

Connect provided MMI wire(White) to OEM wire(Yellow/White)(Behind the command)

# 3. Settings

## 3.1 DIP Switch

- ※ Example DIP S/W usage
  - Use input mode : A/V2, A/V3
  - Use original navigation
  - External rear camera



※ ON : DOWN / OFF : UP  
Default : #8 OFF

- ▷ DIP S/W : 1,2 → ON (hide INPUT MODE)
- ▷ DIP S/W : 3 → OFF (A/V2 display)
- ▷ DIP S/W : 4 → OFF (A/V3 display)
- ▷ DIP S/W : 5 → OFF (High Resolution)
- ▷ DIP S/W : 6 → OFF (Standard GUI model)
- ▷ DIP S/W : 7 → ON (display external rear cam)
- ▷ DIP S/W : 8 → OFF

PIN	Function	Dip S/W Selection
1	Displaying RGB input	ON : RGB mode skip OFF : RGB mode display
2	Displaying A/V 1	ON : A/V 1 mode skip OFF : A/V1 mode display
3	Displaying A/V 2	ON : A/V 2 mode skip OFF : A/V2 mode display
4	Displaying A/V 3	ON : A/V 3 mode skip OFF : A/V3 mode display
5	Setup for Resolution of monitor	ON : Low resolution OFF : High resolution
6		N.C
7	Setup of rear camera use	ON : CVBS4 OFF : MAIN
8	Reset factory settings (not use for user)	ON : Product factory reset OFF : DEFAULT

※ Please make sure to disconnect the power cable of the interface and reconnect the power cable again to apply the dip switch setting whenever changing DIP switch. Otherwise, DIP switch setting will not be applied.

# 3. Settings

## 3.2 Remote Control



<i>Key</i>	<i>Function</i>
POWER & PIP	Unavailable
MENU	Activating OSD menu
OK	Making a selection, changing image display
▲	Moving upward
▼	Moving downward
◀	Moving leftward (If you press this button 2 seconds long, you can access the factory mode.)
▶	Moving rightward (If you press this button 2 seconds long, you can reset all the data about user environment.)

# 3. Settings

## 3.3.1 FACTORY MODE-IMAGE, PARK

FACTORY mode – Press ◀ button 2 seconds long on the remote control.



### □ IMAGE

Adjust navigation position and size

H-POSITION : Move display horizontally

V-POSITION : Move display vertically

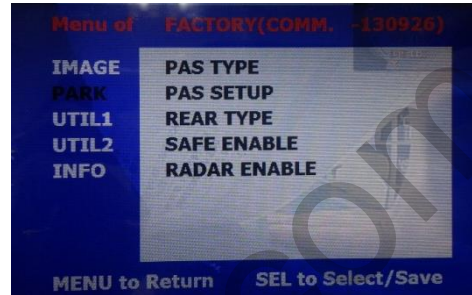

### □ PARK

PAS TYPE : Selecting Type of parking guide line

- NOT USED : Not use Parking guide line
- PAS ON : Selecting Dynamic Parking guide line
- PAS OFF : Selecting fixed Parking guide line

PAS SETUP : Adjusting the position and Selecting type of the parking guide line

REAR TYPE : Choose rear camera recognition

- \* LAMP - Detecting the rear view camera via rear lamp (Installer must connect "Rear-C" cable of the power cable to the rear lamp of the car.)
- \*CAN - Detecting the rear view camera by CAN signal (Installer must connect "CAN" cable of the power cable to the "CAN" cable of the car.)

SAFE ENABLE : If your car is connected with CAN cable and it is in "ON" state, you can NOT watch DVD or A/V except original image or navigation while driving. At that time the screen get back to the main (default : OFF)

RADAR ENABLE : When set the gear to "R", Display PDC



# 3. Settings

## 3.3.1 FACTORY MODE-IMAGE, PARK

### PAS SETUP

Go to Factory Menu, choose PAS SETUP, by using OK button change H-POS → V-POS → TYPE

#### □ H-POS

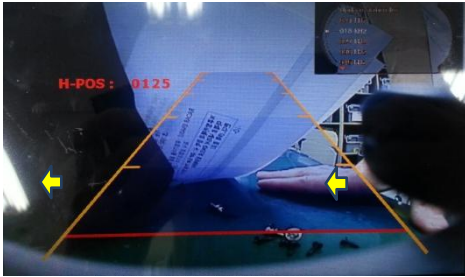

In H-POSITION, use ◀, ▶ on remote control, to adjust parking guideline left and right.

#### □ V-POS

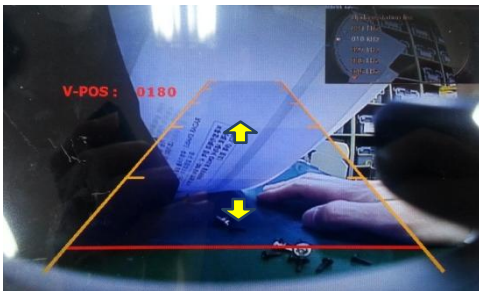

In V-POSITION, use ▲, ▼ on remote control, to adjust parking guideline up and down.

#### □ TYPE



In TYPE, use ▲, ▼ on remote control, to select parking guide line Type for rear camera.

0001 : wide parking guide line

0000 : narrow parking guide line

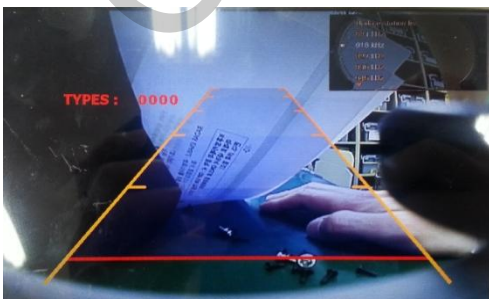

# 3. Settings

## 3.3.2 FACTORY MODE-UTIL1

FACTORY mode – Press ◀ button 2 seconds long on the remote control.

### ▪ Setup for navigation

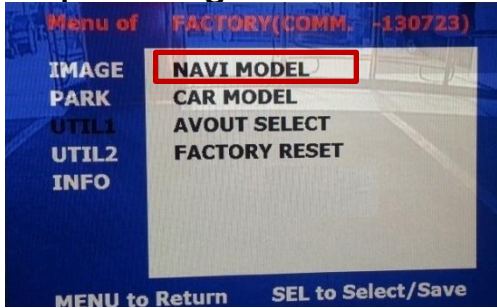

### ☐ UTIL1 – NAVI MODEL

Definition of the navigation resolution

DEFAULT : default, 400X234, in low resolution

KD-900(WVGA) : 800x480 in high resolution, for Chinese

LS-901(WQVGA) : 800x480 in high resolution, for Chinese, Taiwan

WP9200(WVGA) : 800x480 in high resolution, for Israel

GI-8000N 3D(WVGA) : 800x480 in high resolution, for Korea

GI-5000A(WVGA) : 800x480 in high resolution, for Korea

I-ONE(WVGA) : 800x480 in high resolution, for Korea

PAPAGO(WQVGA) : 480x234 in low resolution, for Taiwan

HDMI (when SMI installed): 800x480 in high resolution

**\* Go into FACTORY/ IMAGE (as shown right) and adjust the position and the size of the navigation after setting the definition of the navigation**

### ▪ Setup for car model



### ☐ UTIL1 - CAR MODEL

Selecting model of the car

AUDI S4

AUDI A4

AUDI A6

AUDI A7

AUDI A8

AUDI Q3

AUDI Q5

AUDI Q7

**\* Set pin#5 of DIP switch to the right size of the monitor after selecting model of the car. (Refer to page9.)**

# 3. Settings

## 3.3.2 FACTORY MODE-UTIL1

FACTORY mode – Press ◀ button 2 seconds long on the remote control.



### UTIL1 – AVOUT SELECT

Selecting background sound  
After  
returning navigation or original  
mode

DEFAULT : Selecting AV sound  
just before changing  
navigation or original mode  
from the AV mode

AV 1~3 : Sound of the selected  
AV source 1~3

### UTIL1 - FACTORY RESET

FACTORY MODE RESET

# 3. Settings

## 3.3.3 FACTORY MODE-UTIL2

FACTORY mode – Press ◀ button 2 seconds long on the remote control.

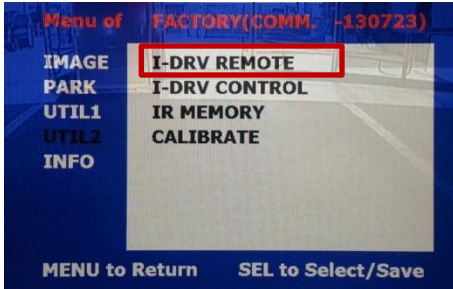

### UTIL2 - I\_DRV REMOTE

Choose DTV and DVD model to be control I\_DRV function

LI-1DISC

NEC-6DISC

USER(when using IR MEMORY)

- Select DVD model: Setting on AV1 Mode
- Select DTV model : Setting on A/V2 mode

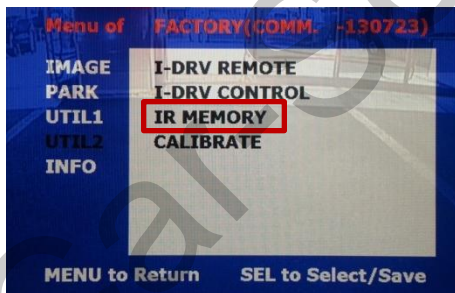

### UTIL2 – IR MEMORY

To register DVD, DTV remote control, the remote control value must be registered and can be control with I-Drive DVD(A/V1), DTV(A/V2)

※ To use this function, in UTIL2-I\_DRV REMOTE select USER mode

### UTIL2 - I\_DRV CONTROL

Selecting whether to use I\_DRV function or not

ON / OFF

A/V1 : Control DVD Remote control UI

A/V2 : Control DTV Remote control UI

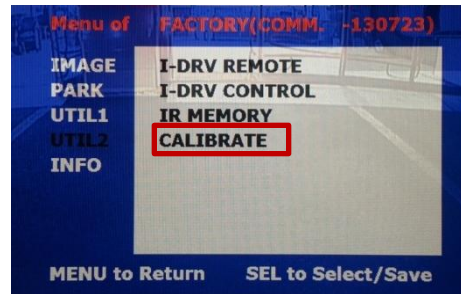

### UTIL2 – CALIBRATE

Touch Calibration

YES / NO

# 3. Settings

## 3.3.3 FACTORY MODE-UTIL2

FACTORY mode – Press ◀ button 2 seconds long on the remote control.

### □ UTIL2 – IR MEMORY

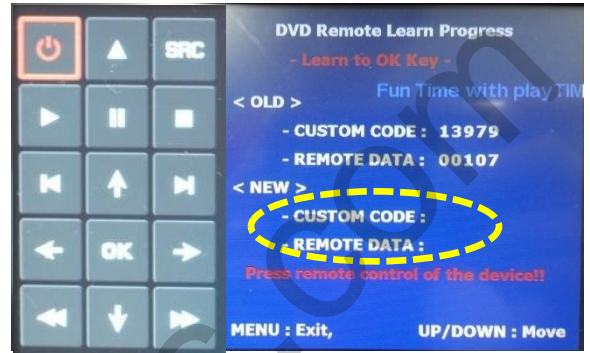
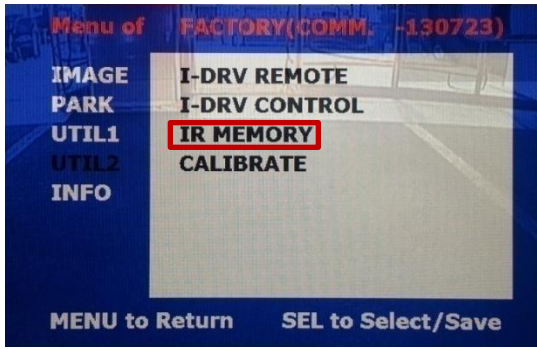

- ① First of all, press ◀ button on remote controller 2 seconds long or press UP→DOWN→UP→MENU button in order to access Factory mode. Choose IR MEMORY on UTIL2.

In IR MEMORY, you can choose AV source of DTV and DVD you want to use.

- ② Picture above shows DVD remote control button value input, select menu you want to save. (To register DVD remote control button value, select IR MEMORY – DTV and follow below instructions.

Example)

- a. After select OK button on OSD menu, press intended I-Drive button
- b. Indicated part above will flicker, and press POWER on DVD remote control. (continue to next page)

### What is IR-MEMORY Mode?

Is to allow MMI and touch screen to control other DVD or DTV (besides the existing,; for example : SANYO, NECVOX) by register remote control value.

# 3. Settings

## 3.3.3 FACTORY MODE-UTIL2

FACTORY mode – Press ◀ button 2 seconds long on the remote control.

### □ UTIL2 – IR MEMORY



Instruction> continued...

c. The values that you registered will appear as green text in the marked area on pressing the button. And the values will be saved automatically.

d. Register remain buttons' value in OSD menu like the above-mentioned.

- ③ After register, select "SRC" button in OSD menu. Then you can see confirmation window as shown above. At the moment, (If data is saved, DVD TYPE and DTV TYPE will be changed to "USER" automatically.)

If you see "SUCCESS" on screen, the data is saved clearly and you can control DVD via touch screen. BUT, you MUST change the option in FACTORY-UTIL2-I\_DRV REMOTE to "USER".

- ※ When touch the middle of the screen, you can control DVD, DTV using remote control UI via touch screen or MMI
- ※ If touch the screen in DVD(A/V1), DTV(A/V2) mode, Can see remote control UI
- If touch the screen in RGB, A/V3 mode, Can see mode switching UI
- If you want to see mode switching UI in DVD, DTV mode, Select "SRC" button

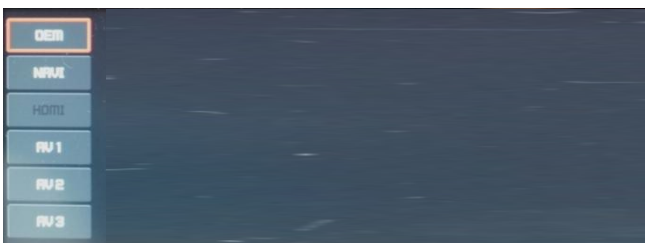

# 3. Settings

---

## 3.3.3 FACTORY MODE-UTIL2

FACTORY mode – Press ◀ button 2 seconds long on the remote control.

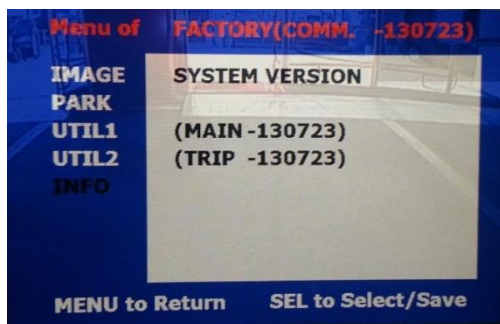

### INFO

Check main version and Trip version

# 3. Settings

---

## 3.4 Original Button Usage

- ※ User can switch mode using  button in steering wheel
  - \* Press longer : Switching mode(RGB→A/V1~3→Original mode)
  - \* Press shorter : Move to Original mode
  
- ※ User can switch mode using “NAV” button in MMI
  - \* Press longer : Switching mode(RGB→A/V1~3→Original mode)
  - \* Press shorter : Move to Original mode



# 3. Settings

## 3.5 OSD (On Screen Display) / Analog RGB Mode



### □ IMAGE

- \* BRIGHTNESS
- \* CONTRAST
- \* SHARPNESS



### □ OSD

- \*LANGUAGE : Set OSD language (only support English and Chinese)
- \* TRANS : Adjust OSD transparency
- \*H-POSITION : Move OSD horizontally
- \* V-POSITION : Move OSD vertically

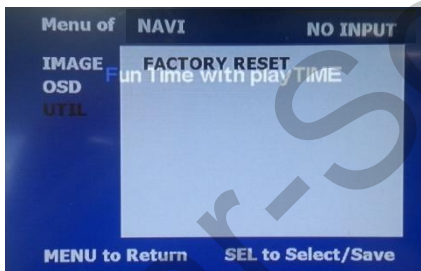

### □ UTIL

- \* FACTORY RESET  
: Factory reset only for OSD function  
(unable reset video position)

# 3. Settings

## 3.5 OSD (On Screen Display) / Video Mode



### □ IMAGE

- \* BRIGHTNESS
- \* CONTRAST
- \* SATURATION
- \* HUE
- \* SHARPNESS

### □ OSD

- \* LANGUAGE : Set OSD language (only support English and Chinese)
- \* TRANS : Adjust OSD transparency
- \* H\_POSITION : Move OSD horizontally
- \* V\_POSITION : Move OSD vertically

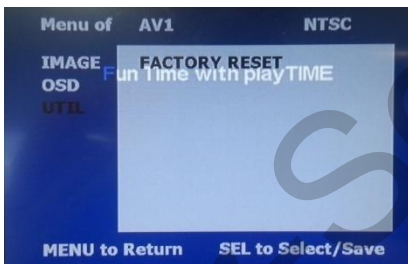

### □ UTIL

- \* FACTORY RESET  
: Factory reset only for OSD function (unable reset video position)

# 4. Trouble Shooting

---

**Q. I cannot change mode**

- A. Check connection of Ground cable and IR Cable.  
Check LED lamp is on, if not check connection of POWER cable.

**Q. All I got on the screen is black.**

- A. .Check second LED lamp of the interface is on, if not, check A/V sources connected are working well.  
(Second lamp indicates AV sources connected works well.) Check interface connection has been done well.

**Q. Displayed image color is not proper (too dark or unsuitable color)**

- A. Try to select "INITIAL" in OSD menu, if it does not work, inform to manufacturer.

**Q. I cannot watch the rear camera on the screen**

- A. Set the DIP switch #7 as state "ON".

**Q. Set mode not appear**

- A. Check DIP Switch.

**Q. OEM image is not displayed.**

- A. Check interface's LCD In/Out cable connection. If the status keeps on, inform to manufacturer.

**Q. Screen only displays white color.**

- A. Check LCD out cable is connected well, if this status keeps, inform to manufacturer.

**Q. Show PIP function via handle button, and original screen appear half only.**

- A. This is not because of faulty interface, please check original monitor split function settings.

**Q. After connect CAN cable, set gear "P", video doesn't appear.**

- A. Go to "FACTORY MODE" and check "UTIL-Rear Select". Change "LAMP" settings to "CAN" with remote control.

※ LAMP : In case of connecting "Rear-C" wire of Power Cable to Rear Lamp in vehicle.

It may not work on a camera with 12V